

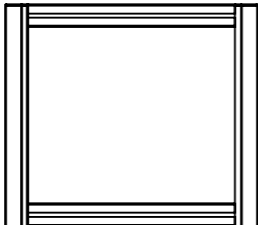

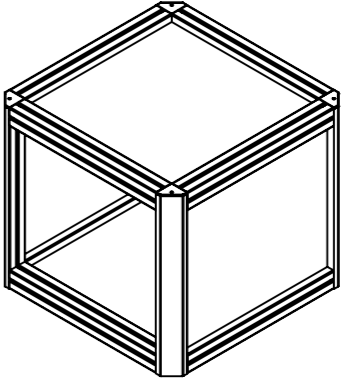

	1	2	3	4	5	6	7	8
A								
B								
C								
D								
E								
F								

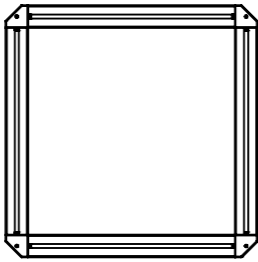





9	Sivulevy	10013			PL8 440x380	1
8	Sivulevy, kolottu	10013A				1
7	Päätylappu 45-45deg.	22.0995				4
6	MiniTec PowerLock Short	21.0020				16
5	Takalevy	10012			PL8 440x380	1
4	Pohjalevy	10029			PL8 440x440	2
3	Profiili		MiniTec 20,1006		45x45 L=410	4
2	Profiili		MiniTec 20,1006		45x45 L=410	4
1	Profiili		MiniTec 20,1029		45x45deg L=437	4
Osa Item	Nimitys Description	Piir. no. Dwg no.	Standardi Standard	Materiaali Material	Mitat Dimensions	Kpl Qty
Yleistoleranssi / General tolerances			Asiakas / Customer		Suunnittelija / Designed	Pvm / Date
SFS-EN 22768-1, SFS-EN ISO 13920			Customer 1			15/04/2019 13.37.2
		Massa / Mass	Projekti / Project		Tarkastaja / Checked	Pvm / Date
		kg	10000			
		Mittakaava / Scale	Työnumero / Work number		Tehdään kpl / Quantity manufactured	
		A3 1:15				
 www.cadworks.fi			Nimitys / Description		Piirustusnumero / Drawing number	Rev
			Runko		10001	

Rev	Muutos / Change	Pvm / Date	Suunnittelija / Designed
1			